

10.1" Capacitive Touch Monitor

FT101TMBCAPOB

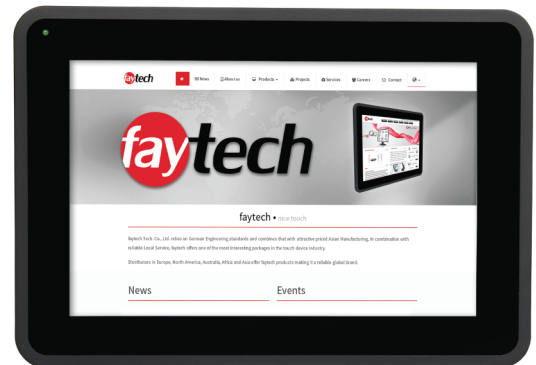

- Anti-glare surface treatment (chemical etching)
- 10-Finger-Multi Touch Capacitive Touch Panel
- 1.1mm cover glass with 7H surface hardness
- Optically bonded Touch Panel to LCD Panel
- Patented IP65 front with silicon seal
- Integrated audio speakers (2x2w)
- 2 year guarantee

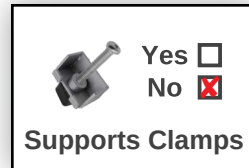

faytech's Capacitive Touch Monitors have a modern sleek look with its flat edge to edge glass IP65 water- and dust proof front panels. This device has capacitive 10-finger multitouch (40-finger for 86" device), glass front reaching MosH 7, the glass surface is anti-glare treated (chemical etching) and a wide variety of connectors. All the monitors have VESA 75 or VESA 100 screw patterns on the back, while the 13.3" to 21.5" come with their own desktop stand included.

This device has an optically bonded touch panel, which will improve the stability, reduce the reflection, increase the viewing angle, and enhance the perceived brightness. It also provides resistance to dust particles and shows a better image in general.

These devices are the perfect choice for a wide variety of applications, including POS systems, control panels in industrial fields, kiosk systems, office/residence automation, digital signage and in areas like shopping malls, classrooms, hotels and many more.

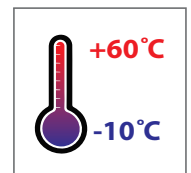
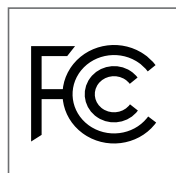
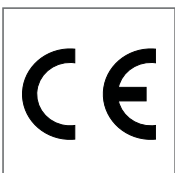

Product name	10.1" Capacitive Touch Monitor
Article code / EAN number	FT101TMBCAPOB / 6920734010141

IP Rating	
IP65 Front / IP40 Back	

LCD Panel	
Screen diagonal (Inch/cm)	10.1/25.65
Display active screen size (cm)	21.70×13.60
Aspect ratio	16:10
Physical resolution	1280×800
Maximum showable resolution	1920×1200
Colours displayed	16.7M
Brightness (cd/m²)	350
Contrast	800:1
Typical reaction time Tr/ Tf (ms)	10/15
Visual Angle horizontal/vertical (°)	170/170
Backlight / Backlight Lifetime (hours)	LED / 20,000

External Connectors	
Video	1x HDMI 1.3 (incl. HDCP)
	1x DVI-D
	1x VGA
Audio	1x PC-Audio
Touch Connector	1x USB
Connectors	1x 12V DC-In (screwable)

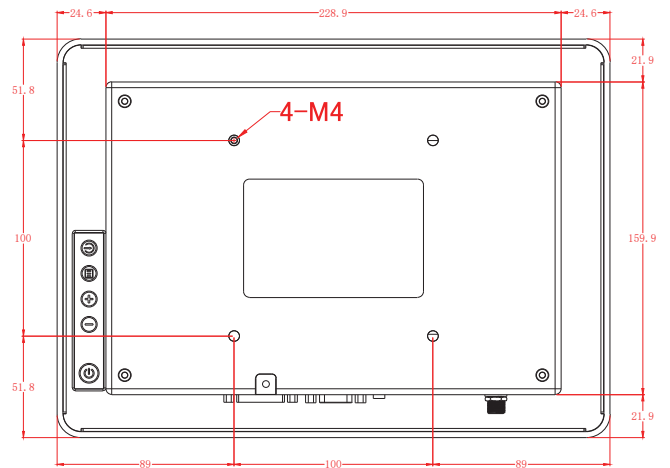
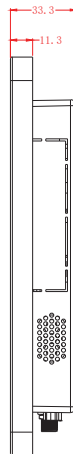
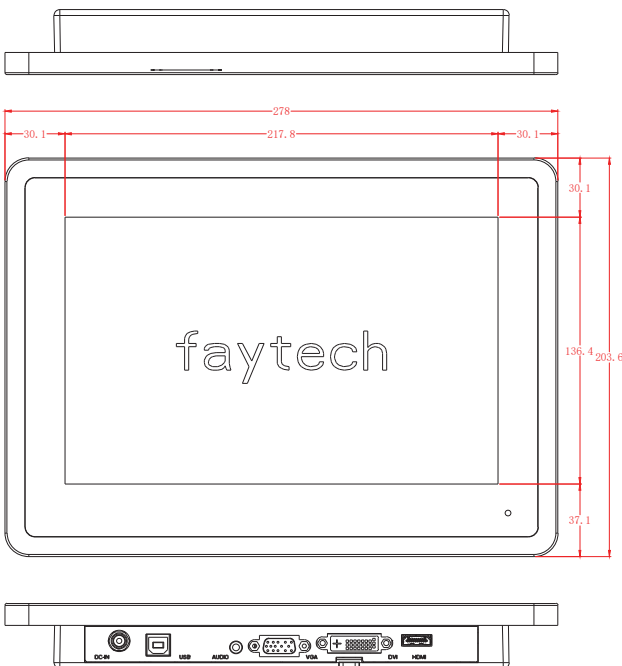

Tolerance: ± 1mm

Touch Panel	
Touch Technology	Projected Capacitive 10-point Multitouch
Touch Panel Drivers	Windows; Linux; Mac; Android
Touch Life (Contacts)	Unlimited
Surface Hardness	7H
Surface Treatment	Anti-glare (chemical etching)

Operation / Mechanical	
Operating Temperature (°C)	-10 ~ +60
Humidity Range (RH)	10% - 90%
Net weight (kg)	0.95
Gross weight (kg)	2.20 (incl. cartonage)
Housing material	Rubber front, Plastic ABS back case
Housing (mm) L × W × H	278.0 × 203.6 × 33.3
Cut-out for clamp supports (mm) L × H	N/A
Amount of clamps required	N/A
Mounting	VESA 100

Power	
Power Indicator	Green LED
Power Supply	100-240V ACDC active switching; 12V DC-Out
Working Power (V)	12
Power Consumption (W)	10
Stand-By Consumption (W)	<1

Included in the Delivery	
Power Supply (see Power section)	
Short Installation Manual	
Cables - VGA, USB Touch, Audio Cable	

Corporate Headquarters

faytech AG
 Bischhäuser Aue 10
 37213 Witzenhausen
 Germany

support@faytech.com
contact@faytech.com
www.faytech.com

China: +86 755 8958 0612
 Germany: +49 5542 30374 10
 USA: +1 646 205 3214
 India: +91 11 49707436
 Japan: +070 4127 5167